

LEARNING PLAYLISTS

Find collections of resources on specific topics handpicked by DAU experts. Search by topic or browse. Follow the playlist to quickly access it again.

Most Recent A-Z DCWF 19 Results

DAU Virtual Instructor-led Training



DCWF Cyber Defense Analyst (511) - Basic Foundational Training Playlist

This learning pathway provides Defense Acquisition University (DAU) courses and workshops that enable the learner to meet the training...

Playlist

DAU Workshop



DCWF Cyber Defense Analyst (511) - Intermediate Foundational Training Playlist

This learning pathway provides Defense Acquisition University (DAU) courses and workshops that enable the learner to meet the training...

Playlist

DAU Workshop



DCWF Cyber Defense Incident Responder (531) - Basic Foundational Training Playlist

This learning pathway provides Defense Acquisition University (DAU) courses and workshops that enable the learner to meet the training...

Playlist

DAU Workshop



DCWF Cyber Defense Incident Responder (531) - Intermediate Foundational Training Playlist

This learning pathway provides Defense Acquisition University (DAU) courses and workshops that enable the learner to meet the training...

Playlist

DAU Virtual Instructor-led Training



DCWF Cyber Defense Infrastructure Support Specialist (521) - Basic Foundational Training Playlist

This learning pathway provides Defense Acquisition University (DAU) courses and workshops that enable the learner to meet the training...

Playlist

DAU Workshop



DCWF Cyber Defense Infrastructure Support Specialist (521) - Intermediate Foundational Training Playlist

This learning pathway provides Defense Acquisition University (DAU) courses and workshops that enable the learner to meet the training...

Playlist

DAU Workshop



DCWF ISSD (631) Basic Foundational Training Playlist

This learning pathway provides Defense Acquisition University (DAU) courses and workshops that enable the learner to meet the training...

Playlist

DAU Workshop



DCWF ISSD (631) Intermediate Foundational Training Playlist

This learning pathway provides Defense Acquisition University (DAU) courses and workshops that enable the learner to meet the training...

Playlist

DAU Workshop



DCWF ISSM (722) - Advanced Foundational Training Playlist

This learning pathway provides Defense Acquisition University (DAU) courses and workshops that enable the learner to meet the training...

Playlist

DAU Workshop



DCWF ISSM (722) - Basic Foundational Training Playlist

This learning pathway provides Defense Acquisition University (DAU) courses and workshops that enable the learner to meet the training...

Playlist

DAU Online Training



DCWF ISSM (722) - Intermediate Foundational Training Playlist

This learning pathway provides Defense Acquisition University (DAU) courses and workshops that enable the learner to meet the training...

Playlist

DAU Workshop



DCWF Security Architect (652) - Intermediate Foundational Training Playlist

This learning pathway provides Defense Acquisition University (DAU) courses and workshops that enable the learner to meet the training...

Playlist

DAU Workshop



DCWF Security Control Assessor (SCA)(612) - Basic Foundational Training Playlist

This learning pathway provides Defense Acquisition University (DAU) courses and workshops that enable the learner to meet the training...

Playlist

DAU Workshop



DCWF Security Control Assessor (SCA)(612) - Intermediate Foundational Training Playlist

This learning pathway provides Defense Acquisition University (DAU) courses and workshops that enable the learner to meet the training...

Playlist

DAU Virtual Instructor-led Training



DCWF System Security Analyst (461) - Basic Foundational Training Playlist

This learning pathway provides Defense Acquisition University (DAU) courses and workshops that enable the learner to meet the training...

Playlist

DAU Workshop



DCWF System Security Analyst (461) - Intermediate Foundational Training Playlist

This learning pathway provides Defense Acquisition University (DAU) courses and workshops that enable the learner to meet the training...

Playlist

CLEARED For Open Publication

Mar 31, 2025

Department of Defense OFFICE OF PRE-PUBLICATION AND SECURITY REVIEW

Feedback



WRC 121 Exploitation Analyst Playlists

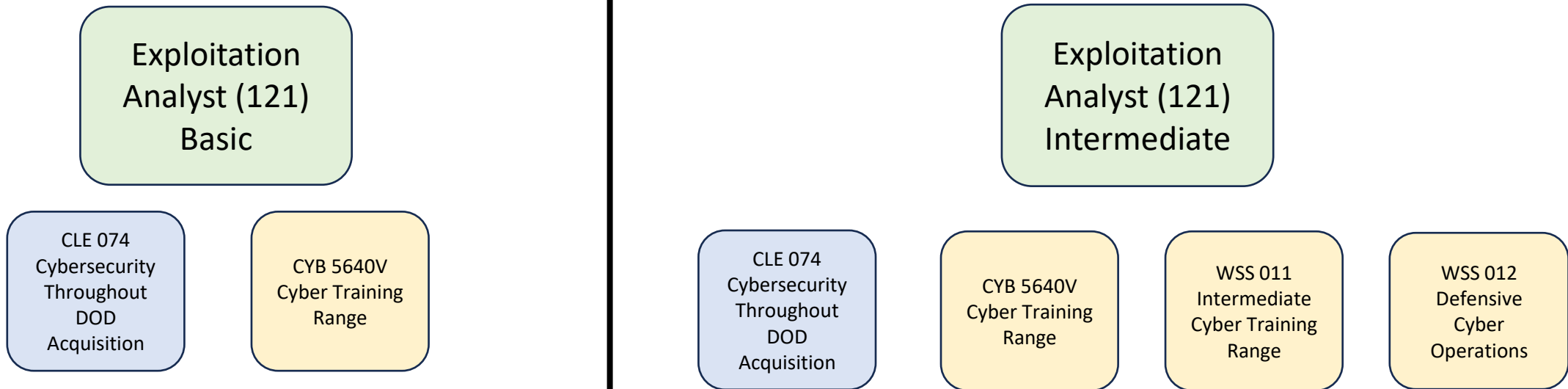

Legend

Online

ILT/VILT

WRC 132 Target Network Analyst Playlists

Target Network Analyst (132) Basic

CLE 074
Cybersecurity
Throughout
DOD
Acquisition

CYB 5640V
Cyber Training
Range

Target Network Analyst (132) Intermediate

CLE 074
Cybersecurity
Throughout
DOD
Acquisition

CYB 5640V
Cyber Training
Range

WSS 011
Intermediate
Cyber Training
Range

Target Network Analyst (132) Advanced

CLE 074
Cybersecurity
Throughout
DOD
Acquisition

CYB 5640V
Cyber Training
Range

WSS 011
Intermediate
Cyber Training
Range

WSS 012
Defensive
Cyber
Operations

Legend

Online

ILT/VILT

WRC 212 Cyber Defense Forensics Analyst Playlist

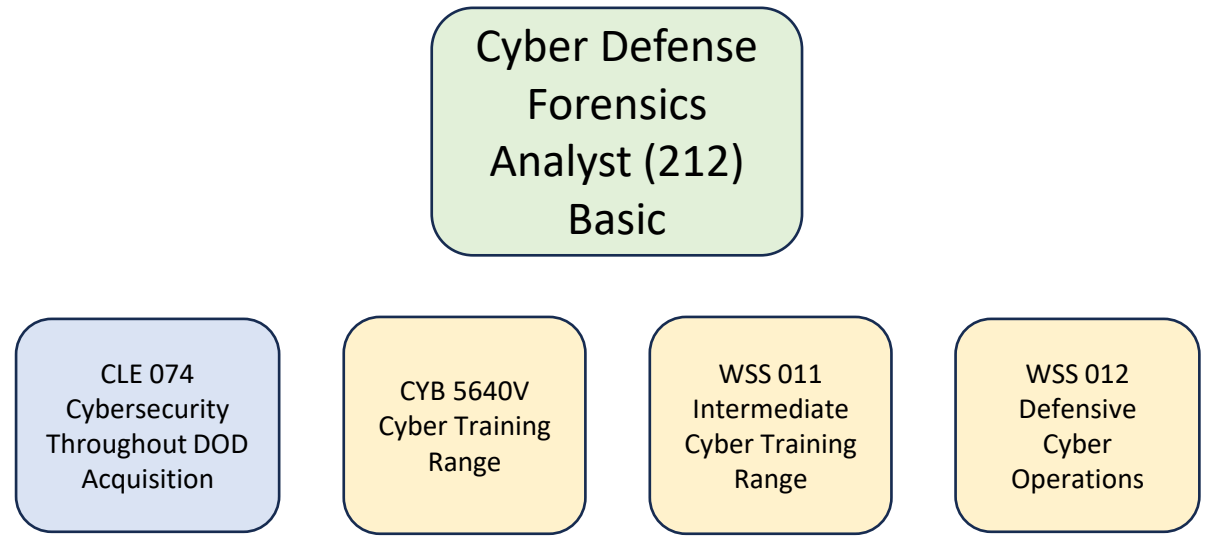

Legend

- Online
- ILT/VILT

WRC 332 Cyber Operations Planner Playlists

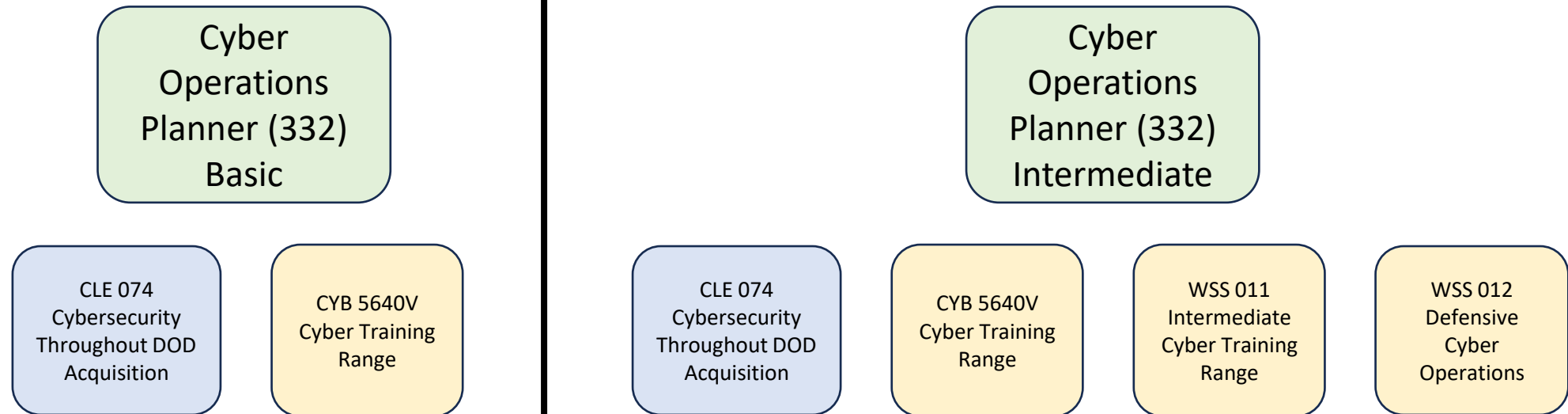

Legend

Online

ILT/VILT

WRC 461 System Security Analyst Playlists

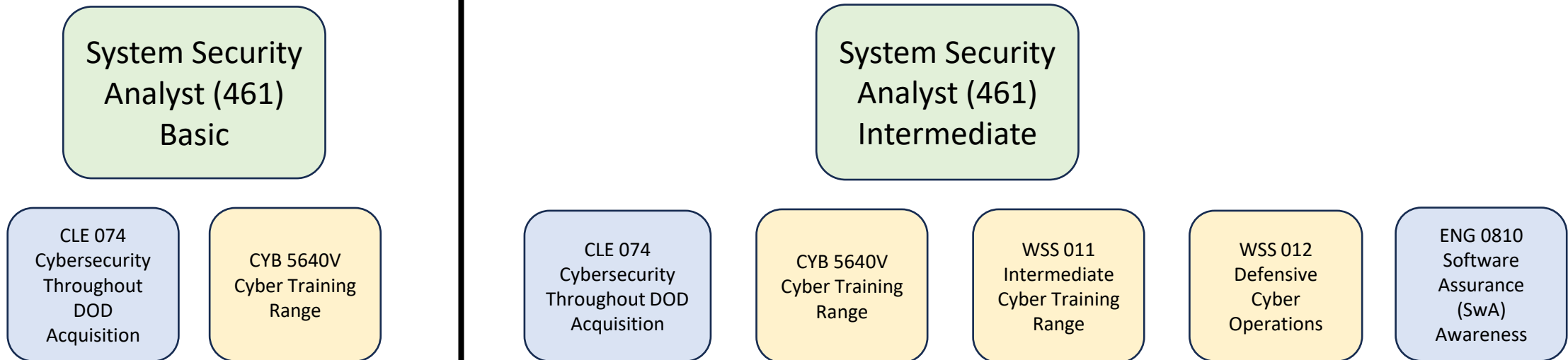

Legend

Online

ILT/VILT

WRC 462 Control Systems Security Specialist Playlist

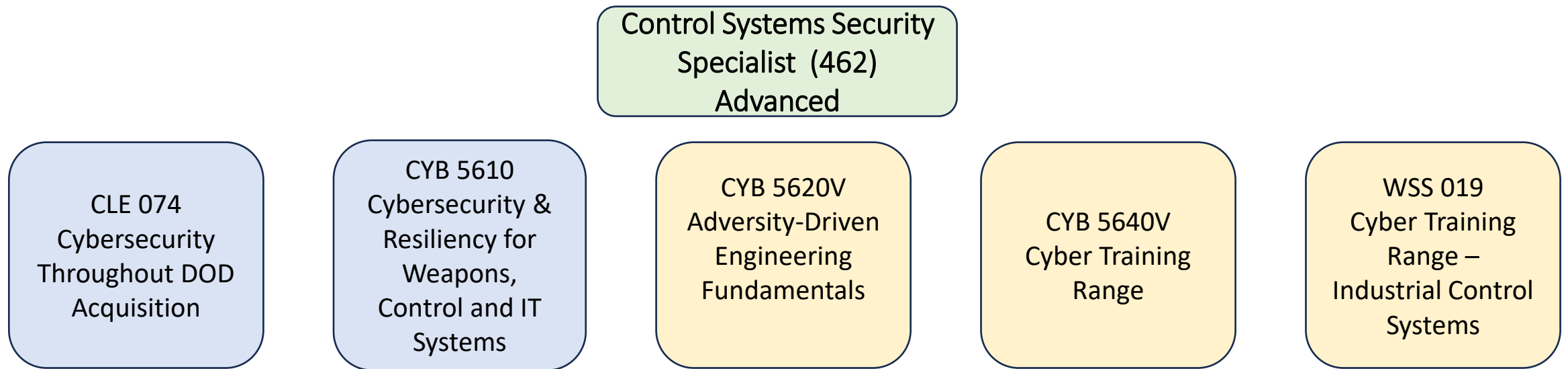

Legend

Online

ILT/VILT

WRC 511 Cyber Defense Analyst Playlists

Cyber Defense Analyst (511) Basic

CLE 074
Cybersecurity Throughout DOD Acquisition

CYB 5640V
Cyber Training Range

Cyber Defense Analyst (511) Intermediate

CLE 074
Cybersecurity Throughout DOD Acquisition

CYB 5640V
Cyber Training Range

WSS 011
Intermediate Cyber Training Range

Cyber Defense Analyst (511) Advanced

CLE 074
Cybersecurity Throughout DOD Acquisition

CYB 5640V
Cyber Training Range

WSS 011
Intermediate Cyber Training Range

WSS 012
Defensive Cyber Operations

Legend

Online

ILT/VILT

WRC 521 Cyber Defense Infrastructure Support Specialist Playlists

Cyber Defense Infrastructure Support Specialist (521) Basic

CLE 074
Cybersecurity Throughout DOD Acquisition

CYB 5640V
Cyber Training Range

Cyber Defense Infrastructure Support Specialist (521) Intermediate

CLE 074
Cybersecurity Throughout DOD Acquisition

CYB 5610
Cybersecurity & Resiliency for Weapons, Control and IT Systems

CYB 5640V
Cyber Training Range

WSS 011
Intermediate Cyber Training Range

WSS 012
Defensive Cyber Operations

Legend

Online

ILT/VILT

WRC 531 Cyber Defense Incident Responder Playlists

Cyber Defense
Incident
Responder
(531)
Basic

CLE 074
Cybersecurity
Throughout
DOD
Acquisition

CYB 5640V
Cyber Training
Range

WSS 011
Intermediate
Cyber Training
Range

WSS 012
Defensive
Cyber
Operations

Cyber Defense
Incident
Responder
(531)
Intermediate

CLE 074
Cybersecurity
Throughout
DOD
Acquisition

CYB 5640V
Cyber Training
Range

WSS 011
Intermediate
Cyber Training
Range

WSS 012
Defensive
Cyber
Operations

Legend

Online

ILT/VILT

WRC 541 Vulnerability Assessment Analyst Playlists

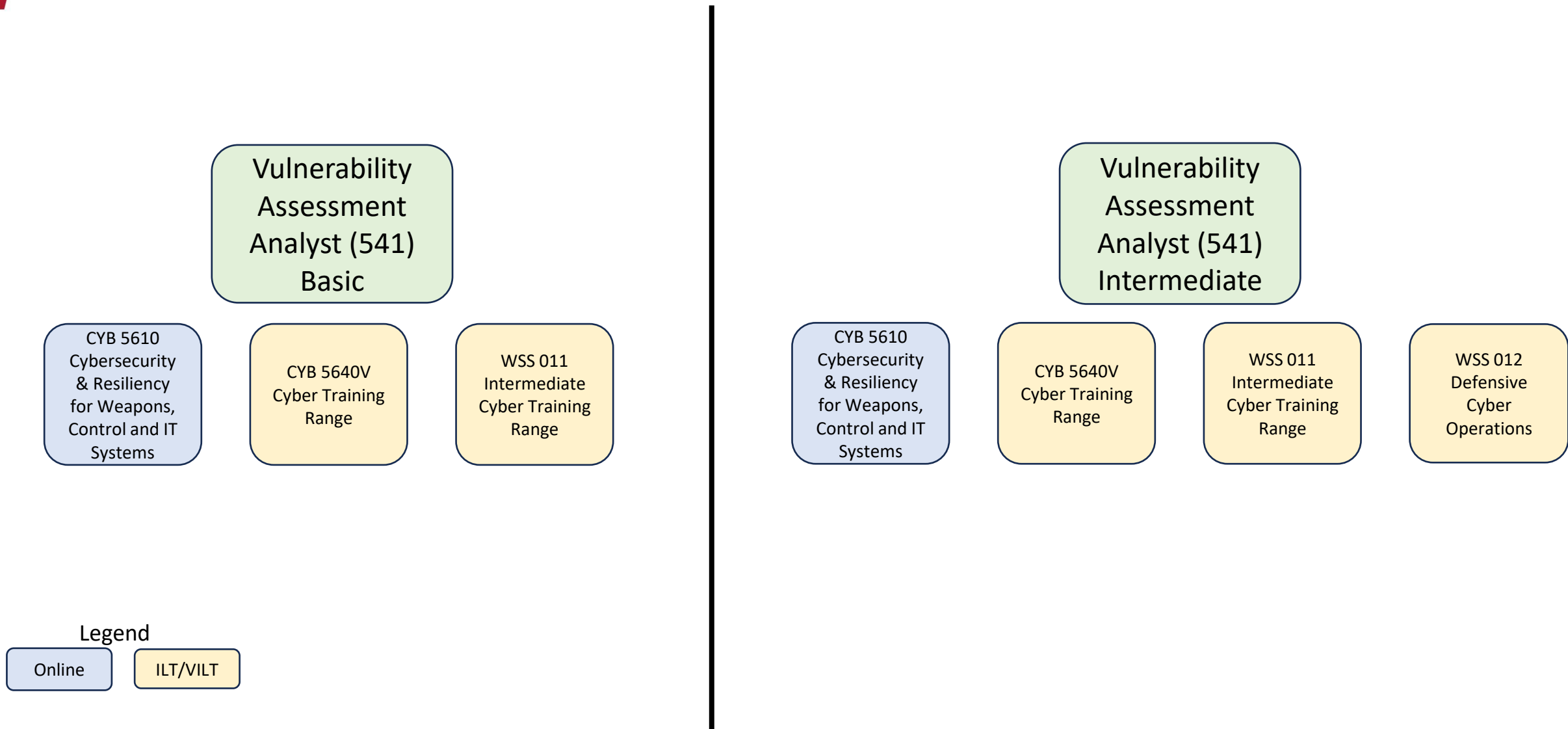

WRC 611 Authorizing Official/Designated Representative (AO/DR) Playlists

AO/DR (611) Basic

CLE 074
Cybersecurity
Throughout DOD
Acquisition

ISA220 Risk
Management
Framework for the
Practitioner

WSS 003
Information System
Security Manager
(ISSM)

AO/DR (611) Intermediate

CLE 074
Cybersecurity
Throughout
DOD
Acquisition

ISA220 Risk
Management
Framework for
the
Practitioner

WSS 003
Information
System
Security
Manager
(ISSM)

CYB 5640V
Cyber Training
Range

WSS 018
Advanced
Cyber Training
Range Aviation
Systems

WSS 019
Advanced Cyber
Training Range
Industrial
Control Systems

AO/DR (611) Advanced

CLE 074
Cybersecurity
Throughout
DOD
Acquisition

ISA220 Risk
Management
Framework for
the
Practitioner

WSS 003
Information
System
Security
Manager
(ISSM)

CYB 5640V
Cyber Training
Range

WSS 018
Advanced
Cyber Training
Range Aviation
Systems

WSS 019
Advanced Cyber
Training Range
Industrial
Control Systems

CCYB 003
Fundamental
Secure Cyber
Resilient
Engineering
Credential

Legend

Online

ILT/VILT

Credential

WRC 612 Security Control Assessor (SCA) Playlists

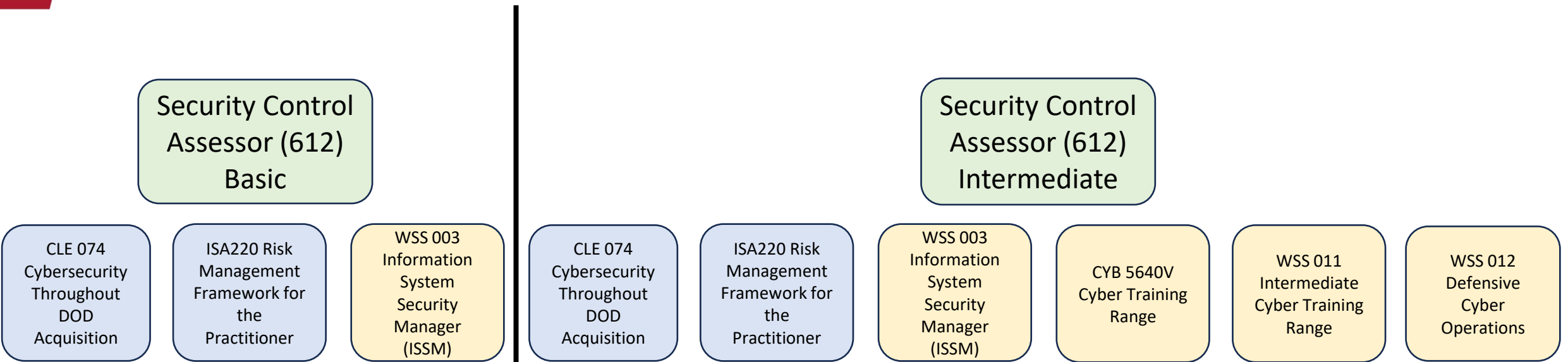

Legend

Online

ILT/VILT

WRC 631 Information Systems Security Developer Playlists

ISSD (631) Basic

CLE 074
Cybersecurity
Throughout
DOD
Acquisition

CYB 5640V
Cyber Training
Range

WSS 011
Intermediate
Cyber Training
Range

WSS 012
Defensive
Cyber
Operations

ISSD (631) Intermediate

CLE 074
Cybersecurity
Throughout
DOD
Acquisition

CYB 5640V
Cyber Training
Range

WSS 011
Intermediate
Cyber Training
Range

WSS 012
Defensive
Cyber
Operations

CLCL 009
Information
Technology
Lifecycle
Support
Credential

Legend

Online

ILT/VILT

WRC 652 Security Architect Playlists

Security Architect (652) Basic

CLE 074
Cybersecurity
Throughout DOD
Acquisition

CYB 5610
Cybersecurity &
Resiliency for
Weapons, Control
and IT Systems

CYB 5640V
Cyber Training
Range

Legend

Online

ILT/VILT

Credential

Security Architect (652) Intermediate

CLE 074
Cybersecurity
Throughout
DOD
Acquisition

CYB 5610
Cybersecurity
& Resiliency
for Weapons,
Control and IT
Systems

ETM 1110
Stakeholder
Requirements

CYB 5640V
Cyber Training
Range

WSS 011
Intermediate
Cyber Training
Range

WSS 012
Defensive
Cyber
Operations

CCYB 003
Fundamental
Secure Cyber
Resilient
Engineering
Credential

WSS 018
Advanced
Cyber Training
Range Aviation
Systems

Security Architect (652) Advanced

CLE 074
Cybersecurity
Throughout
DOD
Acquisition

CYB 5610
Cybersecurity
& Resiliency
for Weapons,
Control and IT
Systems

ETM 1110
Stakeholder
Requirements

CYB 5640V
Cyber Training
Range

WSS 011
Intermediate
Cyber Training
Range

WSS 012
Defensive
Cyber
Operations

CCYB 003
Fundamental
Secure Cyber
Resilient
Engineering
Credential

CCYB 004
Intermediate
Secure Cyber
Resilient
Engineering
Credential

WSS 018
Advanced
Cyber Training
Range Aviation
Systems

WSS 019
Advanced Cyber
Training Range
Industrial
Control Systems

WRC 661 Research and Development Specialist Playlists

R&D Specialist (661) Basic

CLE 066 Systems Engineering for Systems of Systems

ETM 1040 Technical Management Fundamentals

ETM 3110 IT Foundations

CCYB 003 Fundamental Secure Cyber Resilient Engineering Credential

Legend

Online

Credential

R&D Specialist (661) Intermediate

CLE 066 Systems Engineering for Systems of Systems

ETM 1040 Technical Management Fundamentals

ETM 3110 IT Foundations

ETM 1110 Stakeholder Requirements

CCYB 003 Fundamental Secure Cyber Resilient Engineering Credential

CCYB 001 Program Protection Credential

CCYB 004 Intermediate Secure Cyber Resilient Engineering Credential

R&D Specialist (661) Advanced

CLE 066 Systems Engineering for Systems of Systems

ETM 1040 Technical Management Fundamentals

ETM 3110 IT Foundations

ETM 1110 Stakeholder Requirements

CCYB 003 Fundamental Secure Cyber Resilient Engineering Credential

CCYB 001 Program Protection Credential

CCYB 004 Intermediate Secure Cyber Resilient Engineering Credential

ETM 2060 Product Realization for Practitioners

ETM 3150 Introduction to Emerging Technology

STM 0020 Fundamentals of Science and Technology Protection

STM 2050 Science and Technology Strategy

WRC 672 AI Test and Evaluation Specialist Playlists

AI Test and Evaluation Specialist (672) Basic (16 Hours)

CLE 074 Cybersecurity Throughout DOD Acquisition

CENG 003 AI Foundations for the DoD Credential

CLE 074 Cybersecurity Throughout DOD Acquisition

ENG 1410 Intro to AI in System Safety Engineering

ETM 3140 Introduction to Machine Learning and AI

ENG 1400 Intro to AI in Reliability and Maintainability

CENG 003 AI Foundations for the DoD Credential

TST 0510 What is AI in Test and Evaluation

AI Test and Evaluation Specialist (672) Intermediate (18 Hours)

CLE 074 Cybersecurity Throughout DOD Acquisition

ETM 3140 Introduction to Machine Learning and AI

ENG 1410 Intro to AI in System Safety Engineering

TST 0520 AI-Enabled Capabilities Requiring T&E

AI Test and Evaluation Specialist (672) Advanced (26 Hours)

CENG 003 AI Foundations for the DoD Credential

ENG 1400 Intro to AI in Reliability and Maintainability

TST 0510 What is AI in Test and Evaluation

Legend

Online

Credential

WRC 722 Information Systems Security Specialist Playlists

ISSM (722) Basic

CLE 074
Cybersecurity
Throughout
DOD
Acquisition

ISA220 Risk
Management
Framework for
the
Practitioner

WSS 003
Information
System
Security
Manager
(ISSM)

CYB 5640V
Cyber Training
Range

CLE 080
SCRM for
Information and
Communications
Systems

ISSM (722) Intermediate

CLE 074
Cybersecurity
Throughout
DOD
Acquisition

ISA220 Risk
Management
Framework for
the
Practitioner

WSS 003
Information
System
Security
Manager
(ISSM)

CYB 5640V
Cyber Training
Range

CLE 080
SCRM for
Information and
Communications
Systems

ENG 0810
Software
Assurance
(SwA)
Awareness

WSS 011
Intermediate
Cyber Training
Range

WSS 018
Advanced
Cyber Training
Range Aviation
Systems

ISSM (722) Advanced

CLE 074
Cybersecurity
Throughout
DOD
Acquisition

ISA220 Risk
Management
Framework for
the
Practitioner

WSS 003
Information
System
Security
Manager
(ISSM)

CYB 5640V
Cyber Training
Range

CLE 080
SCRM for
Information and
Communications
Systems

ENG 0810
Software
Assurance
(SwA)
Awareness

WSS 011
Intermediate
Cyber Training
Range

WSS 018
Advanced
Cyber Training
Range Aviation
Systems

ACQ 160
Program
Protection
Planning

WSS 012
Defensive
Cyber
Operations

CYB 5630
Cyber Table
Top

WSS 019
Advanced Cyber
Training Range
Industrial
Control Systems

Legend

Online

ILT/VILT

WRC 723 COMSEC Manager Playlists

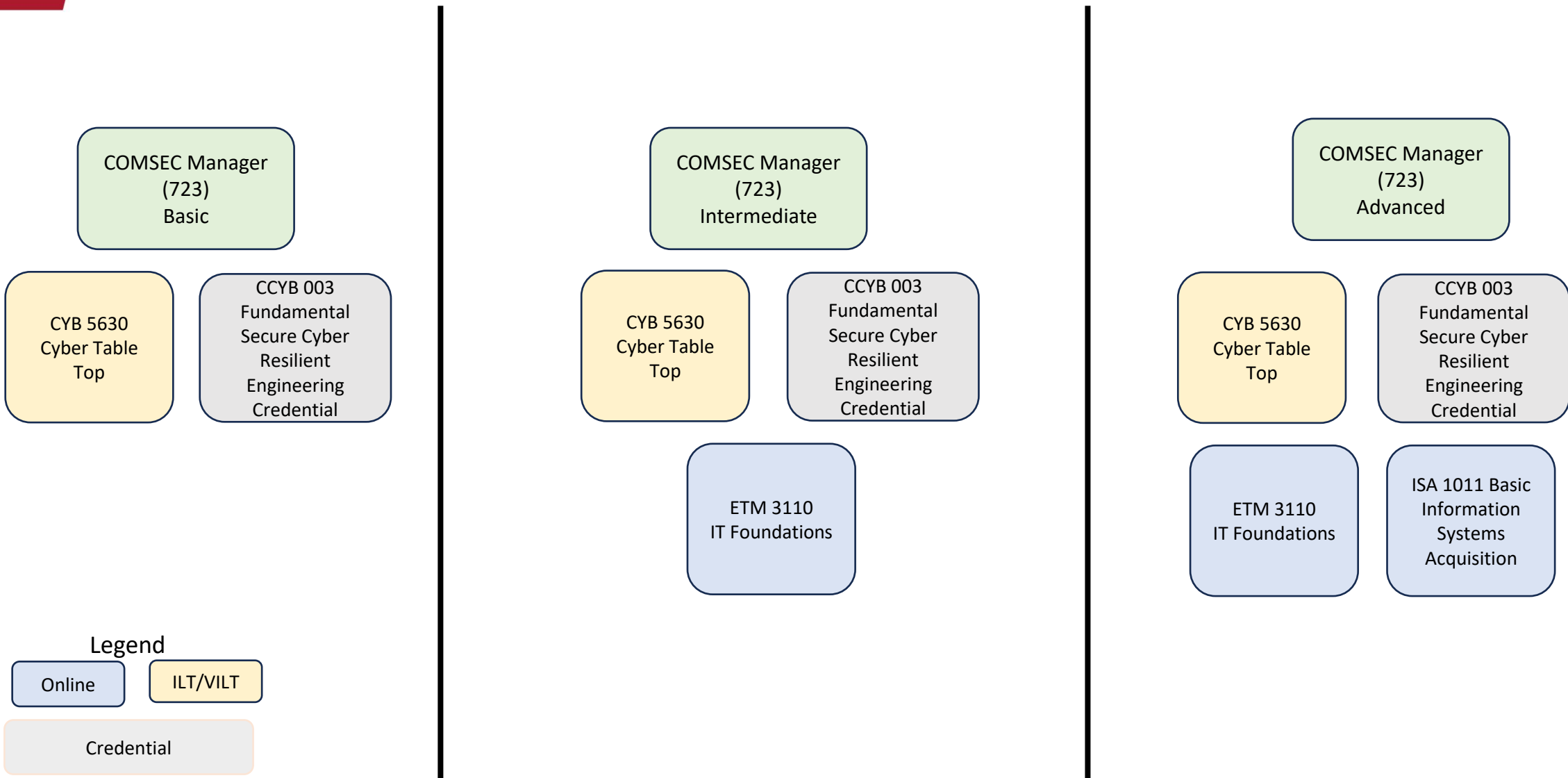

WRC 733 AI Risk and Ethics Specialist Playlists

AI Risk and Ethics Specialist (733)
Basic
(16 Hours)

CLE 074
Cybersecurity Throughout DOD Acquisition

CENG 003 AI Foundations for the DoD Credential

AI Risk and Ethics Specialist (733)
Intermediate
(18 Hours)

CLE 074
Cybersecurity Throughout DOD Acquisition

ETM 3140
Introduction to Machine Learning and AI

CENG 003 AI Foundations for the DoD Credential

AI Risk and Ethics Specialist (733)
Advanced
(25 Hours)

CLE 074
Cybersecurity Throughout DOD Acquisition

ETM 3140
Introduction to Machine Learning and AI

CENG 003 AI Foundations for the DoD Credential

ENG 1410
Intro to AI in System Safety Engineering

ENG 1400
Intro to AI in Reliability and Maintainability

TST 0510
What is AI in Test and Evaluation

Legend

Online

Credential

WRC 753 AI Adoption Specialist Playlists

AI Adoption Specialist (753) Basic (16 Hours)

CLE 074 Cybersecurity Throughout DOD Acquisition

CENG 003 AI Foundations for the DoD Credential

AI Adoption Specialist (753) Intermediate (18 Hours)

CLE 074 Cybersecurity Throughout DOD Acquisition

ETM 3140 Introduction to Machine Learning and AI

CENG 003 AI Foundations for the DoD Credential

AI Adoption Specialist (753) Advanced (25 Hours)

CLE 074 Cybersecurity Throughout DOD Acquisition

ETM 3140 Introduction to Machine Learning and AI

CENG 003 AI Foundations for the DoD Credential

ENG 1410 Intro to AI in System Safety Engineering

ENG 1400 Intro to AI in Reliability and Maintainability

TST 0510 What is AI in Test and Evaluation

Legend

Online

Credential

WRC 801 Program Manager Playlists

Program Manager
(801) Basic
(12 Hours)

CLE 074
Cybersecurity
Throughout
DOD
Acquisition

CCYB 002 or
CCYB 002A
Cybersecurity
for PM
Credential

Program Manager
(801) Intermediate
(22 Hours)

CLE 074
Cybersecurity
Throughout
DOD
Acquisition

ISA 221 Risk
Management
Framework for
the Practitioner

CLE 080 SCRM for
Information and
Communications
Technology (ICT)

CCYB 002 or
CCYB 002A
Cybersecurity for
PM Credential

Program Manager
(801) Advanced
(31 Hours)

CLE 074
Cybersecurity
Throughout
DOD
Acquisition

ISA 220 or ISA
221 Risk
Management
Framework for
the Practitioner

CLE 080 SCRM for
Information and
Communications
Technology (ICT)

CCYB 002 or
CCYB 002A
Cybersecurity for
PM Credential

CENG 012
Technology Project
Management
Credential

Legend

Online

Credential

WRC 802 IT Project Manager Playlists

IT Project Manager
(802) Basic
(12 Hours)

CLE 074
Cybersecurity
Throughout
DOD
Acquisition

CCYB 002 or
CCYB 002A
Cybersecurity
for PM
Credential

Legend

Online

Credential

IT Project Manager
(802) Intermediate
(21 Hours)

CLE 074
Cybersecurity
Throughout
DOD
Acquisition

CCYB 002 or
CCYB 002A
Cybersecurity
for PM
Credential

CENG 012
Technology
Project
Management
Credential

IT Project Manager
(802) Advanced
(44 Hours)

CLE 074
Cybersecurity
Throughout
DOD
Acquisition

CCYB 002 or
CCYB 002A
Cybersecurity
for PM
Credential

CENG 012
Technology
Project
Management
Credential

CENG 013
Technology
Portfolio
Management
Credential

WRC 803 Product Support Manager Playlists

Product Support
Manager (803)
Basic
(12 Hours)

CLE 074
Cybersecurity
Throughout
DOD
Acquisition

CCYB 002 or
CCYB 002A
Cybersecurity
for PM
Credential

Legend

Online

ILT/VILT

Credential

Product Support
Manager (803)
Intermediate
(36 Hours)

CLE 074
Cybersecurity
Throughout
DOD
Acquisition

CCYB 002 or
CCYB 002A
Cybersecurity
for PM
Credential

CYB 5630V Cyber
Table Top

Product Support
Manager (803)
Advanced
(74 Hours)

CLE 074
Cybersecurity
Throughout
DOD
Acquisition

CCYB 002 or
CCYB 002A
Cybersecurity
for PM
Credential

CYB 5630V Cyber
Table Top

CLCL 017 Supply
Chain Resiliency
Credential

WRC 804 IT Investment/Portfolio Manager Playlists

IT Investment/Portfolio Manager (804) Basic (12 Hours)

CLE 074 Cybersecurity Throughout DOD Acquisition

CCYB 002 or CCYB 002A Cybersecurity for PM Credential

IT Investment/Portfolio Manager (804) Intermediate (21 Hours)

CLE 074 Cybersecurity Throughout DOD Acquisition

CCYB 002 or CCYB 002A Cybersecurity for PM Credential

CENG 012 Technology Project Management Credential

IT Investment/Portfolio Manager (804) Advanced (44 Hours)

CLE 074 Cybersecurity Throughout DOD Acquisition

CCYB 002 or CCYB 002A Cybersecurity for PM Credential

CENG 012 Technology Project Management Credential

CENG 013 Technology Portfolio Management Credential

Legend

Online

Credential

WRC 805 IT Program Auditor Playlists

IT Program Auditor
(805) Basic
(12 Hours)

CLE 074
Cybersecurity
Throughout
DOD
Acquisition

CCYB 002 or
CCYB 002A
Cybersecurity
for PM
Credential

IT Program Auditor
(805) Intermediate
(21 Hours)

CLE 074
Cybersecurity
Throughout
DOD
Acquisition

CCYB 002 or
CCYB 002A
Cybersecurity
for PM
Credential

CENG 012
Technology
Project
Management
Credential

IT Program Auditor
(805) Advanced
(23 Hours)

CLE 074
Cybersecurity
Throughout
DOD
Acquisition

CCYB 002 or
CCYB 002A
Cybersecurity
for PM
Credential

CENG 012
Technology
Project
Management
Credential

CLM 048 Audit
Readiness
Requirements
for DoD
Equipment

Legend

Online

Playlist

WRC 806 Product Manager Playlists

Product Manager
(806)
Basic
(31 Hours)

CLE 074
Cybersecurity
Throughout
DOD
Acquisition

CACQ 011
Foundational
Software
Acquisition
Manager
Credential

Product Manager
(806)
Intermediate
(39 Hours)

CLE 074
Cybersecurity
Throughout
DOD
Acquisition

CCYB 002 or
CCYB 002A
Cybersecurity
for PM
Credential

CACQ 011
Foundational
Software
Acquisition
Manager
Credential

Product Manager
(806)
Advanced
(48 Hours)

CLE 074
Cybersecurity
Throughout
DOD
Acquisition

CCYB 002 or
CCYB 002A
Cybersecurity
for PM
Credential

CENG 012
Technology
Project
Management
Credential

CACQ 011
Foundational
Software
Acquisition
Manager
Credential

Legend

Online

Credential

WRC 902 AI Innovation Leader Playlists

AI Innovation Leader (902) Basic (16 hours)

CLE 074 Cybersecurity Throughout DOD Acquisition

CENG 003 AI Foundations for the DoD Credential

AI Innovation Leader (902) Intermediate (18 hours)

CLE 074 Cybersecurity Throughout DOD Acquisition

ETM 3140 Introduction to Machine Learning and AI

CENG 003 AI Foundations for the DoD Credential

AI Innovation Leader (902) Advanced (25 hours)

CLE 074 Cybersecurity Throughout DOD Acquisition

ETM 3140 Introduction to Machine Learning and AI

CENG 003 AI Foundations for the DoD Credential

ENG 1410 Intro to AI in System Safety Engineering

ENG 1400 Intro to AI in Reliability and Maintainability

TST 0510 What is AI in Test and Evaluation

Legend

Online

Credential